

# 1. Freight Transport

---

## 1.1 Logistics Costs

As shown in Table 1.1, the total U.S. logistics costs for 2021 were \$1.847 trillion, up 11% from 2020, the first decrease since 2018.<sup>1</sup> This represents 8.03% of the U.S. Gross Domestic Product (GDP). In 1981, the first full year of trucking deregulation, logistics costs were 16.2% of GDP<sup>2</sup>; in 2000, they were 10.2%,<sup>3</sup> and in 2009 they were 7.37%, a record low percentage of GDP until 2020's 7.22%.<sup>1</sup> In 1981, transportation and carrying costs represented 45% and 51% of total costs, respectively<sup>4</sup>; in 2016, they represented 64% and 29% of the costs, respectively. In 2016, intercity truck transport (full and LTL) alone represents 37% of the total transportation costs and over 23% of total logistics costs, parcel has surpassed rail for the first time, and total inventory carrying costs as a percentage of the \$3.202 trillion total business inventory were 15.65%.

**Table 1.1. Total 2021 U.S. Logistics Costs<sup>5</sup>**

<b>Transportation Costs</b>		<b>\$ Billion</b>
Motor Carrier:	Full truckload .....	332
	Less-than truckload .....	83
	Private or dedicated .....	415
Parcel .....		135
Rail:	Carload .....	72
	Intermodal .....	16
Airfreight .....		53
Water .....		32
Pipeline .....		67
	<b>Total Transportation Costs</b>	<b>1,206</b>
<b>Inventory Carrying Costs (\$3,202<sup>6</sup> billion total inv.)</b>		
	Financial cost (WACC × total inventory) .....	165
	Storage .....	186
	Other (obsolescence, shrinkage, insurance, others) .....	150
	<b>Total Carrying Costs</b>	<b>501</b>
<b>Other Costs</b>		
	Carriers' support activities .....	77
	Shippers' administrative costs .....	63
	<b>Total Logistics Costs</b>	<b>1,847</b>

## 1.2 Network Design and Transport Costs

The design of a logistics network has a large impact on transport costs. Raw material or finished goods warehouses can be used for consolidation, cross-docking, or breaking bulk purposes in order to achieve transport economies (see Figure 1.1).

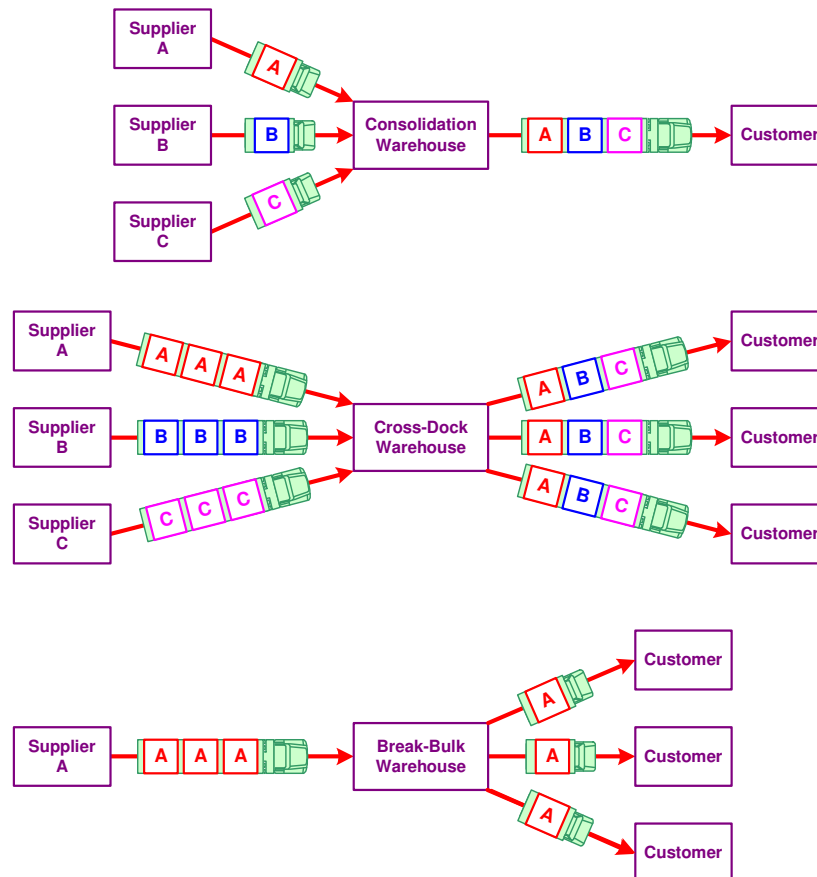

**Figure 1.1. Using a warehouse to reduce transport costs.**

- *Consolidation warehouse:* A consolidation warehouse is used to combine multiple loads into a single load. Instead of costly LTL or infrequent TL shipments from each supplier directly to the customer, a consolidation warehouse provides less-costly and more frequent TL shipments to the customer. Small delivery vans can be used for short-distance transport between the suppliers and the warehouse, and tractor-trailers for long-distance TL transport to the customer. Consolidation warehouses are typically used by wholesalers.
- *Cross-Dock Warehouse:* A cross-dock warehouse is used to mix freight so that TL shipments can be used for all transport between suppliers and customers. Receiving and shipping are usually coordinated so that no storage is required at the warehouse. In distribution, the ideal of no storage can sometimes be realized using cross docking, where there is a direct flow of material from trucks at the receiving docks to the shipping docks without buffering or storage in-between, but cross docking requires detailed planning and coordination (e.g., implemented using EDI) that in many cases may not be feasible.

- *Break-Bulk Warehouse:* At a break-bulk warehouse, a large long-distance TL shipment from a supplier is broken down into smaller loads that are delivered a short-distance to each customer. Break-bulk warehouses are usually located close to or in each major market served.

## 1.3 Modes of Transport

### 1.3.1 Ocean Shipping

Intermodal ISO containers conform to the International Organization for Standardization (ISO) container manufacturing standards. They are used to facilitate loading and unloading at ports and to allow the container to be transported using other modes of transport like trucking and rail. Capacity of ship measured in TEUs (Twenty-foot Equivalent Units), an international standard. Containers were the first “packetized” transport network and were developed in the 1950’s by North Carolina trucker Malcolm McLean, who started Sea-Land based in Charlotte.<sup>7</sup>

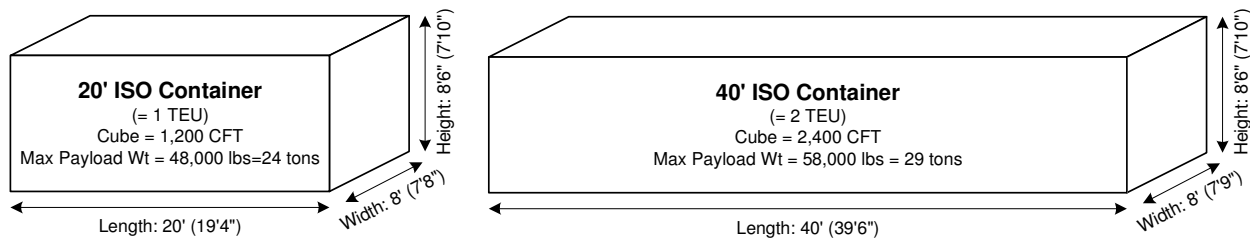

**Figure 1.2. Intermodal ISO containers (interior dimensions in parenthesis).**

Most containers are either 20 foot or 40 foot (see Figure 1.2), although high-cube 9.5-ft high and 45-, 48-, or 53-ft long containers are also available. In 2004, the cost of transporting a 40-ft container from China to the U.S. West Coast is around \$2,400 (plus fees and duties) and takes 16 to 18 days, and the cost from China to the U.S. East Coast is around \$4,000 (plus fees and duties) and takes 26 to 30 days. The cost of transporting a 20-ft container is 70% the cost of a 40-ft container. Containers can also be transported by rail and road. Backhaul is sometimes difficult. The number of containers traveling from the Far East to the U.S. West Coast, 11 million TEUs per year, is 2.5 times the number returning, 4.9 million TEUs.<sup>8</sup>

### 1.3.2 Trucking

Freight can be transported via private trucking or for-hire trucking. For-hire trucking services include full truckload (TL), less-than-truckload (LTL), and package express (PX) (see Table 1.2). TL is 80% of all trucking.<sup>9</sup> PX can also include transport by rail and air, and it also has a limit on the maximum dimension of a load (e.g., 130 in.) in order to allow automated sortation equipment to be used at terminals. “Parcels” are PX loads, while loads under 2 lbs. are referred to as “packets.” Other services include bulk, motor vehicle carrier, refrigerated, and tank car.

Figure 1.3 shows the dimension, cube, and weight capacities of an enclosed van semi-trailer, the most common truck trailer. Refrigerated van semi-trailers are referred to as “reefer” units. The maximum gross weight limit of 80,000 lbs applies to the entire vehicle (i.e., 3-axle tractor and 2-axle 53’ semi-trailer). The maximum payload weight of 50,000 lbs is based on an estimated average “tare” weight for the empty vehicle of approximately 30,000 lbs<sup>10</sup> (13,900 lb tractor and 13,800 lb semi-trailer). Although the *physical cube capacity* of a trailer ranges from 3,332 to 3,968 ft<sup>3</sup> for 48 to 53 ft trailers, respectively, in practice not all of this space can be utilized when different-size items are packed into the trailer, resulting in an *effective cube capacity* from approximately 2,500 to 3,000 ft<sup>3</sup>.

**Table 1.2. U.S. For-Hire Trucking Services<sup>11</sup>**

	TL	LTL	PX
Minimum payload	10,000 lb	150 lb	2 lb
Average payload <sup>12</sup>	30,000 lb	1000 lb	10 lb
Maximum payload	50,000 lb	10,000 lb	70 (UPS) – 150 lb
Average length of haul	294 mi	752 mi	894 mi
Average value	\$775/ton	\$7002/ton	\$37,538/ton

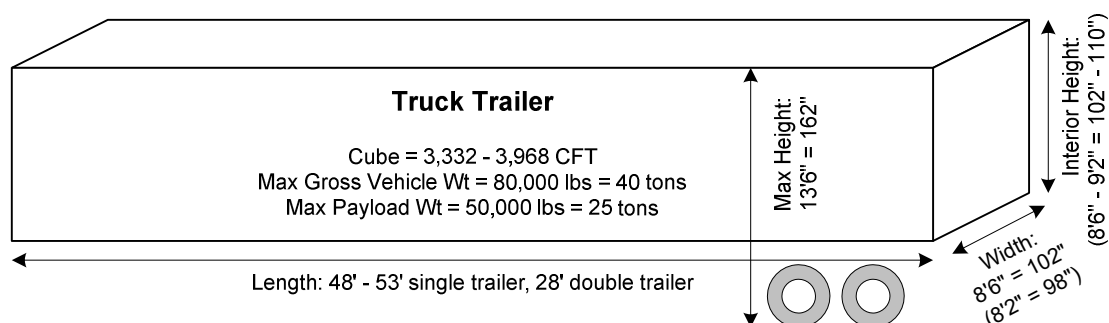

**Figure 1.3. Truck enclosed van semi-trailer (interior dimensions in parenthesis).**

### 1.3.3 Rail

Freight can be transported by carload (CL) or less-than-carload (LCL). Truck trailers can be transported on flatcars (TOFC), and ocean containers can be double-stacked on flatcars (COFC). Figure 1.4 shows a typical boxcar. RailInc is a company located in Cary, NC that tracks the movement of railcars throughout the U.S.

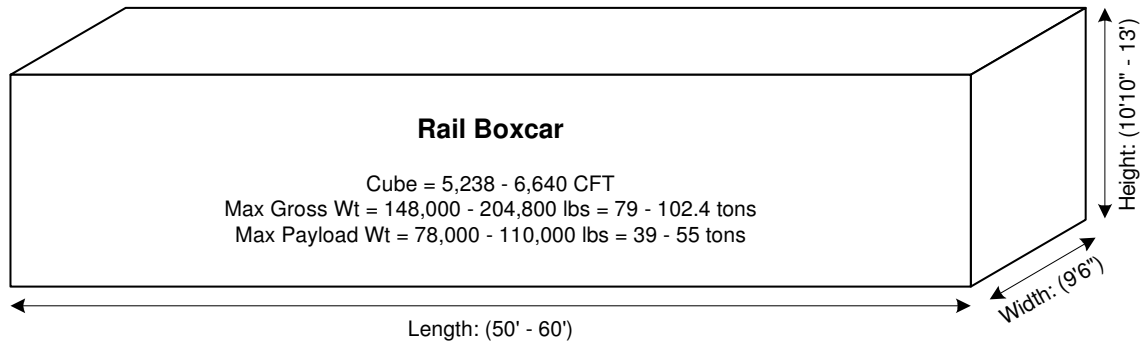

Figure 1.4. Rail boxcar (interior dimensions in parenthesis).

## 1.4 Trucking Operations

Figure 1.5 shows the variety of different routing alternatives that are available for TL trucking operations. Interleaved routing (Figure 1.5(e)) can be difficult to achieve if the trailer only opens at the rear. The major difference between TL and LTL/PX trucking operations is that the latter requires a network of terminals (see Figure 1.6). In a LTL logistics network, loads in the vicinity of a terminal are collected and delivered to the terminal where they are sorted and loaded onto trucks that provide “linehaul” transport to other terminals. There are fewer firms providing LTL as compared to TL services because of the high cost of constructing a network of terminals. Non-revenue-generating empty (or “deadhead”) travel represents approximately 15% of total trucking miles and is used to reposition a tractor-trailer after the final delivery to the next initial pickup point.

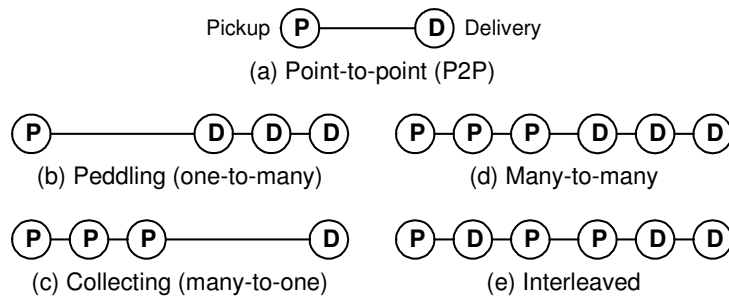

Figure 1.5. TL routing alternatives.

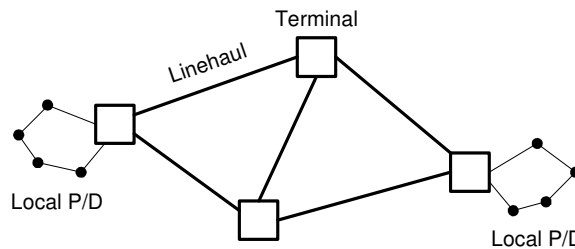

Figure 1.6. Logistics network used for LTL and PX.

As compared to a single shipment transported from its origin to its destination (P2P TL), all of the multi-stop TL routing alternatives shown in Figure 1.5 represent the consolidation of multiple shipments into a single consolidated load. The benefit of consolidation is the potential savings that may accrue from economies of scale in transportation gained by shipping larger loads. As shown in Figure 1.7, consolidated truckloads can be used to transport loads that are smaller than P2P TL and that are of lesser value than LTL.

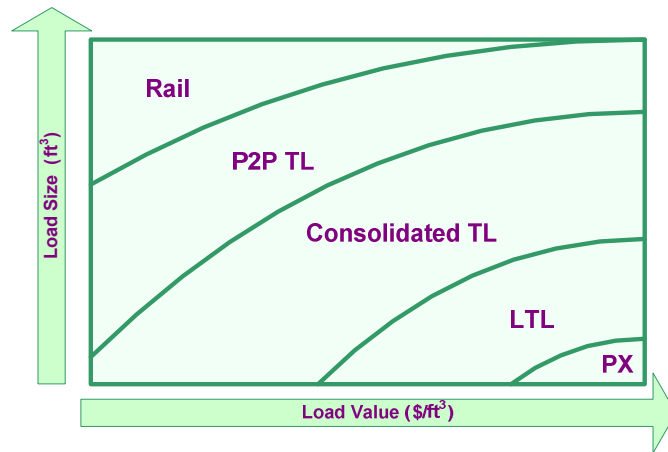

Figure 1.7. Load value versus load size.

### 1.4.1 HOS Regulations

The Federal Motor Carrier Safety Administration’s Hours-of-Service (HOS) regulations provide constraints on the number of hours that a driver can operate a truck: “Drivers may drive up to 11 hours in the 14-hour on-duty window after they come on duty following 10 or more consecutive hours off duty.”<sup>13</sup> The HOS regulations effectively limit the total distance traveled by a single driver in a day to around 400 miles. As a result, a DC is limited to serving customers located within a 200 mile radius if it is desired that drivers return to a home location each day. Similar considerations result in a 200-mile maximum separation between LTL terminals. Team drivers can be used to allow almost continual operation, where each driver must rest at least eight consecutive hours in the sleeper berth per HOS regulations.

## 1.5 One-Time Truck Shipments

The transport mode selected for a particular item is based on the value of item. The cost that is charged to transport single unit of an item via a particular mode (e.g., LCL, LTL) is based on the density of the item. It is more common for a truck enclosed van semi-trailer to *cube out* (i.e., reach its maximum possible cubic volume (e.g., 3500 ft<sup>3</sup> for a truck semi-trailer) than it is to *weigh out* (i.e., reach its maximum weight limit (e.g., 50,000 lb for a truck van semi-trailer): van semi-trailers weigh out only 20% of the time, versus 80% for tank trailers.

The rate paid by a customer for transport service can range anywhere from

- the cost of the service to the provider (the minimum rate) to
- the value of the service to the customer (the maximum rate).

Negotiation is used to set the actual rate within this range based on local market conditions, shipment frequency, etc.

### 1.5.1 TL Transport Charge

In determining the TL transport charge, revenue per loaded-truck-mile is used instead of the cost per truck-mile because the user of the rate model is assumed to be a shipper (i.e., customer) buying TL service from a carrier on the basis of dollars-per-loaded-mile. The average revenue per mile associated with transporting one loaded trailer one-way is estimated to be \$2.00 for the year 2004.<sup>14</sup> The ratio of an unspecified TL Producer Price Index<sup>15</sup> value ( $PPI_{TL}$ ) and 102.7, the value for 2004, can be used to adjust the 2004 estimate of \$2.00 to reflect the revenue per loaded truck-mile of the current period:

$$TL \text{ Transport Charge } (\$): \quad c_{TL} = \left\lceil \frac{q}{q_{\max}} \right\rceil r d \quad (1.1)$$

where

$$\left\lceil \frac{q}{q_{\max}} \right\rceil = \text{number of truckloads per shipment}$$

$$r = \text{TL revenue per loaded truck-mile } (\$/\text{mi})$$

$$= \frac{PPI_{TL}}{102.7} \times \$2.00 / \text{mi} \quad (\text{average estimate})$$

$PPI_{TL}$  = Producer Price Index for TL service (= 102.7 in 2004; 113.5 in 2007; 113.3 in 2010)

$d$  = road distance between the O-D pair (mi)

$q$  = shipment weight (tons)

$q_{\max}$  = maximum payload (tons).

In (1.1), it is assumed that any portion of the load exceeding the maximum payload of the truck is still transported TL using additional trucks.

### Maximum Payload

The maximum payload for a shipment is the maximum size of each truckload and is determined by whether a trailer is constrained by weight or cubic volume:

$$Maximum \text{ Payload } (\text{tons}): \quad q_{\max} = \min \left\{ K_{wt}, \frac{s K_{cu}}{2000} \right\} \quad (1.2)$$

where

$s$  = item density (lb/ft<sup>3</sup>)

$K_{wt}$  = weight capacity of truck trailer (tons)

$K_{cu}$  = cube capacity of truck trailer (ft<sup>3</sup>).

In (1.2), the maximum payload with respect to cubic volume is determined by solving for  $q$  in the following equation:

$$K_{cu} = \frac{q}{\left(\frac{s}{2000}\right)},$$

where  $(s/2000)$  is the density in ton/ft<sup>3</sup>.

**Example:** The transport charge in 2005 to ship  $q = 2$  tons of  $s = 9.72$  lb/ft<sup>3</sup> product 532 mi from Raleigh, NC to Gainesville, FL can be estimated as follows: Using the 2005  $PPI_{TL}$  of 108.6, a weight capacity of 25 tons, and, since the length of the trailer has not been determined, an effective cube capacity of 2,750 ft<sup>3</sup>, which is the midpoint of the effective capacities for 48 to 53 ft trailers.

$$r = (108.6/102.7) \times \$2.00/\text{mi} = \$2.11/\text{mi};$$

$$q_{\max} = \min\{25, 9.72(2750)/2000\} = 13.37 \text{ tons};$$

$$c_{TL} = \lceil 2/13.37 \rceil (2.12) 532 = \$1,125.13.$$

### Aggregate Shipment

When multiple items are shipped together as part of a single load, then it is convenient to view them as a single demand-weighted *aggregate shipment*,<sup>16</sup> where, for  $m$  items, the aggregate weight and aggregate density are

$$q_{\text{agg}} = \sum_{i=1}^m q_i \quad (1.3)$$

$$s_{\text{agg}} = \frac{(\text{aggregate weight, in lb})}{(\text{aggregate cube, in ft}^3)} = \frac{2000 q_{\text{agg}}}{\sum_{i=1}^m 2000 q_i / s_i} = \frac{q_{\text{agg}}}{\sum_{i=1}^m q_i / s_i}, \quad (1.4)$$

where  $q_i$  are in tons and  $s_i$  in lb/ft<sup>3</sup>.

### 1.5.2 Estimated LTL Transport Charge

The following model was developed from tariff rate tables and provides a general means of estimating rates for LTL transport between origin-destination (O-D) pairs located anywhere within the continental United States.<sup>17</sup> Since it requires only distance, weight, and density as inputs and allows direct comparison of LTL and TL rates, it can be used in the earliest stages of logistics network design when location decisions are being made and when the most appropriate

shipment size for each lane (O-D pair) in the network is being determined. In most commercial transportation management and planning systems, LTL rates are determined using tariff tables (e.g., CzarLite), but this requires the shipper/decision maker to purchase access to the tariff tables and, further, to know what discount to apply to the tariff rates.

The model reflects average industry rates and to allow rate estimates to be adjusted to current economic conditions by using the current Producer Price Index for LTL service:

$$LTL \text{ Rate } (\$/\text{ton-mi}): \quad r_{LTL} = PPI_{LTL} \left[ \frac{\frac{s^2}{8} + 14}{\left( q^{\frac{1}{7}} d^{\frac{15}{29}} - \frac{7}{2} \right) (s^2 + 2s + 14)} \right], \quad (1.5)$$

$$LTL \text{ Transport Charge } (\$): \quad c_{LTL} = r_{LTL} q d \quad (1.6)$$

where

$PPI_{LTL}$  = Producer Price Index for LTL service<sup>18</sup> (= 104.2 in 2004; 121.0 in 2007; 126.8 in 2010) and  $\frac{150}{2,000} \leq q \leq \frac{10,000}{2,000}$  (tons),  $37 \leq d \leq 3354$  (mi), and  $2000q/s \leq 650$  (ft<sup>3</sup>), with these

conditions representing the range of input data that produced the estimate and also ensuring that the denominator of (1.5) remains positive. The LTL transport rate is shown as a function of  $q$  and  $d$ . Note that, in actuality, an LTL shipment between any origin and destination is likely to travel a longer distance than the road distance  $d$  because it will travel through one or more transshipment terminals along its journey. However, the road distance between O-D pairs is the only readily available measure of distance, and, since the particular network of transshipment terminals is specific to each LTL carrier, it is the only reasonable measure. The model (1.5) is independent of the particular characteristics of any O-D pair and, since the only parameter that distinguishes O-D pairs is road distance, the resulting rate estimate is symmetric with respect to O-D order, with such differences being treated as noise, reflecting the general nature of the model and its use in reasonably general optimization studies.

### 1.5.3 Minimum Charge

In practice, in addition to the basic P2P TL and LTL charges, there is a minimum charge associated with any shipment that corresponds to the cost of providing the transport service that is not related to the weight of the shipment. There is a separate estimated minimum charge for TL and LTL:

$$TL \text{ Minimum Charge } (\$): \quad MC_{TL} = \left( \frac{r}{2} \right) 45 \quad (1.7)$$

$$\text{LTL Minimum Charge (\$): } MC_{LTL} = \left( \frac{PPI_{LTL}}{104.2} \right) \left( 45 + \frac{d^{\frac{28}{19}}}{1625} \right), \quad (1.8)$$

where  $d > 0$  and  $q > 0$ ;  $MC_{TL} = MC_{LTL} = 0$ , for  $d = 0$  or  $q = 0$ .

The minimum charge for TL is independent of distance and depends solely on loading and unloading costs at the origin and destination of the shipment, while the charge for LTL is a function of the distance of the shipment because each shipment is loaded and unloaded at each LTL terminal visited in transit and the number of terminals visited increases with the length of the shipment.

#### 1.5.4 Independent Shipment Transport Charge

An *independent shipment* corresponds to either a P2P TL shipment or a LTL shipment. It represents an alternative to a multi-stop *consolidated load*, where multiple shipments are carried on a single truck at the same time and the potential savings associated with transporting multiple shipments on the same truck is offset by an increase in the loaded distance that the truck travels as compared to a P2P TL shipment or the charge associated with shipping via LTL. Such consolidated loads differ from multiple shipments with the same origin and destination (O-D) because the latter can be combined together as an aggregate shipment and treated as a single shipment as long as the shipments occur within the same time period, while with the former there is an additional charge associated with transporting the consolidated load.

Using the TL and LTL transport and minimum charges,

$$\text{Independent Transport Charge (\$): } c_0 = \min \left\{ \max \{c_{TL}, MC_{TL}\}, \max \{c_{LTL}, MC_{LTL}\} \right\}. \quad (1.9)$$

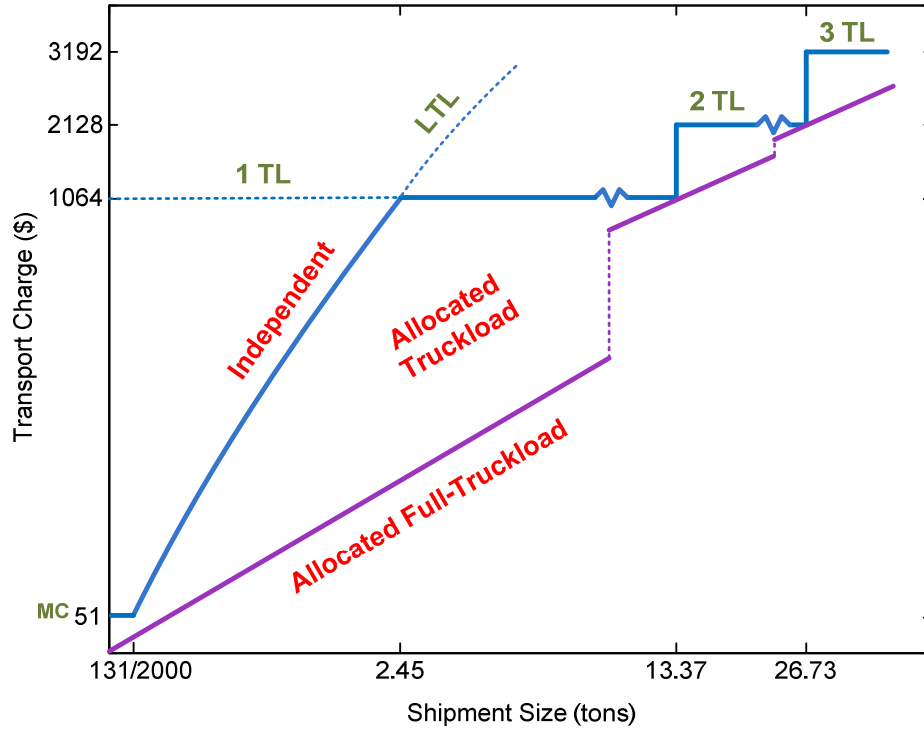

**Figure 1.8. Transport charge for a shipment.**

An example of transport charges for a range of shipment sizes is shown in Figure 1.8. The independent transport charge is the top solid curve in the figure and represents an upper bound on the charge for a given shipment size (the allocated full-truckload charge shown as the bottom curve represents an effective lower bound on the charge and is discussed in more detail in Section 1.7). For the independent transport charge curve, LTL is used for sizes up to 2.45 tons, a single P2P TL truckload for sizes up to the maximum payload of 13.37 tons, two truckloads for up to two times the maximum payload, etc. A minimum charge of \$51.40 is invoked for sizes less than 131 lb. The single independent shipment is from Raleigh, NC to Gainesville, FL and  $s = 9.72 \text{ lb/ft}^3$ ,  $d = 532 \text{ mi}$ ,  $r = \$2/\text{mi}$ ,  $PPI_{LTL} = 104.2$ ,  $K_{wt} = 25 \text{ tons}$ , and,  $K_{cu} = 2,750 \text{ ft}^3$ .

### 1.5.5 Comparing TL and LTL Rates

In Figure 1.9, LTL and TL rates are compared for three different load densities for 532-mile shipments between Raleigh and Gainesville, FL as a function of the shipment weight. The LTL rate is (1.5) and the TL rate is  $r_{TL} = c_{TL}/(qd)$ . The shipment weight that yields equal rates between LTL and TL is labeled in each figure. For this example, the volume and weight capacities of the truck trailer are assumed to be  $K_{cu} = 3,000 \text{ ft}^3$  and  $K_{wt} = 24 \text{ tons}$ , respectively. All of the comparisons are for year 2004, meaning that  $PPI_{LTL} = 104.2$  and  $r = \$2/\text{mi}$ .

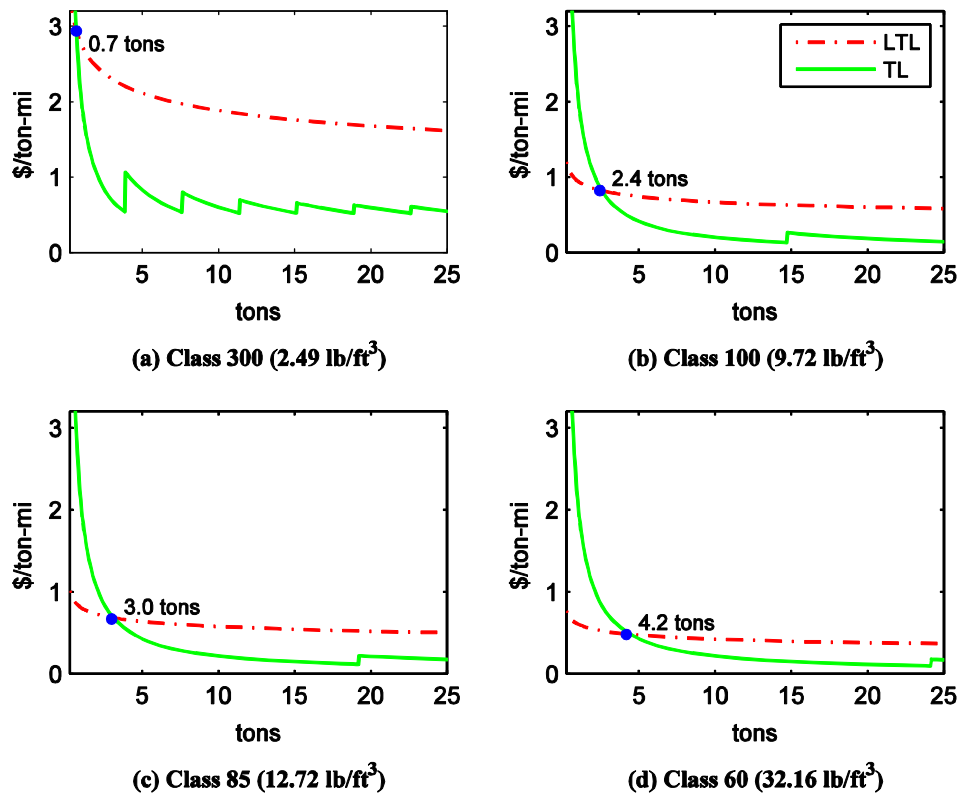

Figure 1.9. TL vs. LTL rates from Raleigh, NC to Gainesville, FL (532 mi).

## 1.6 LTL Tariff

LTL rates are dependent on a number of factors, prominent among them being the specific origin and destination, the weight of the shipment, and the freight class to which the goods being shipped belong. LTL charges are typically determined from rates quoted in a tariff. A separate table is provided in the tariff for each particular pair of origin and destination (O-D) points (typically zip codes) due to different local market conditions like demand imbalances that can result in an excess of empty trailers at some locations (e.g., more freight is shipped to Florida than from Florida, so that rates to Florida are higher than the rates from Florida).

The specific characteristics of each item that impact its transport cost need to be considered in assigning each item to be transported to a freight class, including the following considerations:

1. Load density (e.g., a large item will cube-out a trailer sooner than a smaller item that has the same weight).
2. Special handling (e.g., fragile loads; hazardous materials; unit load size: it is more costly to handle several small loads that comprise a single shipment that together have the weight as a single large unit load).

3. Stowability (e.g., some items can be nested).
4. Liability (e.g., high value items are more expensive to insure while in transit).

The *National Motor Freight Classification*<sup>19</sup> is typically used to determine the rating of an item. Most LTL carriers have a *Freight All Kinds* (FAK) rate that can be used for any item that cannot be classified. Discounts of up to 15% from the published rates are usually available for a single one-time shipment; when a firm has frequent shipments, discounts of 30–65% can usually be negotiated.

**Table 1.3. Class-Density Relationship**  
(italics indicate value at capacity)

Class	Load Density (lb/ft <sup>3</sup> )		Max Physical Weight (tons)	Max Effective Cube (ft <sup>3</sup> )
	Minimum	Average		
500	–	0.52	0.72	2,750
400	1	1.49	2.06	2,750
300	2	2.49	3.43	2,750
250	3	3.49	4.80	2,750
200	4	4.49	6.17	2,750
175	5	5.49	7.55	2,750
150	6	6.49	8.92	2,750
125	7	7.49	10.30	2,750
110	8	8.49	11.67	2,750
100	9	9.72	13.37	2,750
92.5	10.5	11.22	15.43	2,750
85	12	12.72	17.49	2,750
77.5	13.5	14.22	19.55	2,750
70	15	18.01	24.76	2,750
65	22.5	25.50	25	1,961
60	30	32.16	25	1,555
55	35	39.68	25	1,260
50	50	56.18	25	890

Table 1.3 shows the minimum density<sup>20</sup> and average density for each freight class. Also shown in the table is the maximum weight for a shipment assuming a maximum physical payload of 25 tons (50,000 lb) and the maximum cubic volume for a shipment assuming a maximum effective payload of 2,750 ft<sup>3</sup>. A *maximum effective cube capacity* of 2,750 ft<sup>3</sup> is approximately 80–70% of the respective 3,332–3968 ft<sup>3</sup> maximum physical cube capacity of a truck trailer (see Figure 1.3), and is used as an estimated of the lost cube capacity associated with the packing of different size loads into a trailer. If same size loads are packed, then the actual maximum cube capacity of a trailer can be calculated. The *maximum physical weight capacity* is used because there is little potential loss of weight capacity associated with packing loads into a trailer.

The *ideal density*<sup>21</sup> ( $50,000/2750 = 18.18$  lb/ft<sup>3</sup>) is the density at which a full truckload is simultaneously at the tractor-trailer's cubic capacity and its weight capacity. An average freight mix at this density best utilizes both the weight and cube capacities of a tractor-trailer. Shipments weigh-out when their average density is greater than the critical density and cube-out when it is

less. Note that Class 100 represents the “average” load and has an average density of 9.72 lb/ft<sup>3</sup>, which is in the range of densities that cube-out a trailer.

Table 1.4 is an example of a tariff table (CzarLite tariff DEMOCZ02 04-01-2000<sup>22</sup>). It is for the O-D pair Raleigh, NC (ZIP code 27606) to Gainesville, FL (ZIP code 32606). As one can see, LTL rates for a given O-D pair are clearly a function of the class of the freight being shipped (first column of Table 1.4), as established by agencies like the National Motor Freight Traffic Association (NMFTA), and the weight of the shipment (bottom row). In the bottom row of the table, the mid-points of the weight ranges, in tons, at which the rates, in \$/cwt (where cwt is “hundred weight,” or 100 lbs), change, termed *rate breaks*, are provided. The actual road distance spanned by this O-D pair is 532 miles. The minimum charge for this tariff is \$95.23. Rates above 10,000 lb (5 tons) are given in the tariff even though LTL shipments usually do not exceed this weight.

**Table 1.4. Tariff (in \$/cwt) from Raleigh, NC (27606) to Gainesville, FL (32606) (532 mi, CzarLite DEMOCZ02 04-01-2000, minimum charge = \$95.23)**

Freight Class	Rate Breaks ( <i>i</i> )								
	1	2	3	4	5	6	7	8	9&10
500	341.42	314.14	245.80	201.48	158.60	112.37	55.66	55.66	55.66
400	273.88	251.99	197.19	161.61	127.22	91.12	45.10	45.10	45.10
300	206.34	189.85	148.56	121.76	95.85	69.47	34.43	34.43	34.43
250	172.56	158.77	124.23	101.83	80.15	58.03	28.79	28.79	28.79
200	138.78	127.69	99.92	81.89	64.47	47.19	23.40	23.40	23.40
175	121.37	111.68	87.39	71.62	56.38	41.27	20.39	20.39	20.39
150	104.49	96.13	75.22	61.66	48.53	35.96	17.75	17.75	17.75
125	87.59	80.60	63.07	51.69	40.69	30.24	15.00	15.00	15.00
110	77.57	71.37	55.85	45.77	36.04	28.61	14.40	14.40	14.40
100	71.23	65.55	51.29	42.04	33.09	27.58	14.03	10.80	9.90
92	66.48	61.18	47.88	39.24	30.89	25.75	13.68	10.52	9.66
85	61.74	56.80	44.45	36.43	28.68	23.91	13.20	10.15	9.32
77	56.99	52.44	41.04	33.63	26.48	22.07	12.60	9.68	8.89
70	52.77	48.55	37.99	31.14	24.51	20.43	12.00	9.23	8.47
65	50.07	46.08	36.05	29.56	23.04	19.39	11.87	9.14	8.39
60	47.44	43.64	34.15	28.00	21.82	18.37	11.76	9.04	8.30
55	44.75	41.17	32.22	26.40	20.59	17.32	11.64	8.96	8.22
50	41.57	38.26	29.94	24.54	19.12	16.10	11.52	8.85	8.14
<b>Tons (<math>q_i^B</math>)</b>	0.25	0.5	1	2.5	5	10	15	20	$\infty$

Using the tariff information in Table 1.4, Figure 1.10 shows plots of both the transport charge (labeled Total Cost,  $TC_{\text{tariff}}$  in the figure) and the rate per ton-mile for a Class 100 shipment from Raleigh to Gainesville. (Values along both axes in Figure 1.10(a) and along the bottom axis in Figure 1.10(b) are plotted on a log-base-10 scale.) The broken lines plotted in the figure show the total charge and rate without applying any minimum charges or *weight breaks*, the latter of which eliminate any incentive for a shipper to over-declare a shipment weight in order to receive a lower rate. Formally, each table can be represented as a matrix,  $OD$ , containing the freight charge per hundredweight, with the rows in  $OD$  designating the rate class (*class*) and the columns designating the weight grouping or rate break (*i*), as discussed above.

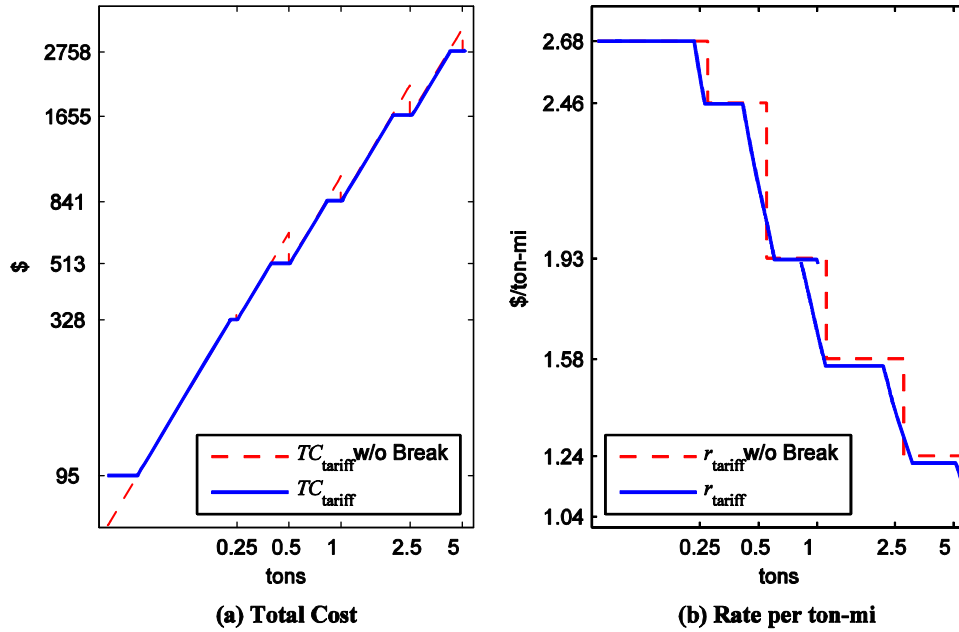

Figure 1.10. LTL tariff from Raleigh, NC to Gainesville, FL for Class 100.

Each rate break  $i$  corresponds to a range  $[q_{i-1}^B, q_i^B)$  of shipment weights (in tons) into which a shipment can fall. Weight breaks occur when the charge for the minimum weight of the next rate break,  $q_i^B$ , is less than the charge in the current rate break. Given this formalization of the tariff table, the tariff transport charge can be computed as:

$$c_{\text{tariff}} = (1 - \text{disc}) \max \left\{ MC, \min \left\{ OD(\text{class}, i) 20q, OD(\text{class}, i+1) 20q_i^B \right\} \right\} \quad (1.10)$$

$$i = \arg \left\{ q_i^B \mid q_{i-1}^B \leq q < q_i^B \right\},$$

where  $q_0^B = 0$ ,  $MC$  is the minimum charge, and  $\text{disc}$  is the discount provided by the carrier, if appropriate. Solving (1.10) for  $q$ , the weight break  $i$  corresponds to

$$q_i^W = \frac{OD(\text{class}, i+1)}{OD(\text{class}, i)} q_i^B. \quad (1.11)$$

For example, using Table 1.4, if one were to ship two tons ( $q = 2$ ) of Class 100 goods ( $\text{class} = 10$  — i.e., the tenth row of Table 1.4) at a 60% discount ( $\text{disc} = 0.6$ ), then  $i = 4$  (since  $1 = q_3^B \leq q < q_4^B = 2.5$ ),  $OD(\text{class}, i) = 42.04$ , the total cost is

$$\begin{aligned} c_{\text{tariff}} &= (1 - 0.6) \max \left\{ 95.23, \min \left\{ 42.04(20)2, 33.09(20)2.5 \right\} \right\} \\ &= 0.4 \max \left\{ 95.23, \min \left\{ 1682, 1655 \right\} \right\} = \$662. \end{aligned}$$

The corresponding weight break is  $q_4^W = 33.09(2.5)/42.04 = 1.97$  tons, which is just below the shipment size of two tons.

### 1.6.1 Comparison of Estimated LTL Charge

In order to compare the LTL transport charge that was determine using the rate estimate (1.5) to the charge as determined using the tariff, the following three O-D test pairs were used:

- Raleigh, NC (27606) to Gainesville, FL (32606): 532 miles
- Detroit, MI (48234) to Dothan, AL (36302): 926 miles
- Black Mountain, NC (28711) to Salt Lake City, UT (84101): 1938 miles.

These test pairs represent different distances and, in each test pair, a larger population city is paired with a smaller population city so that the rates for that lane reflect a balance of high and low demands, as opposed to, for example, lanes connecting two large cities, which are likely to have more frequent and lower-cost service due to greater competition between carriers serving those cities.

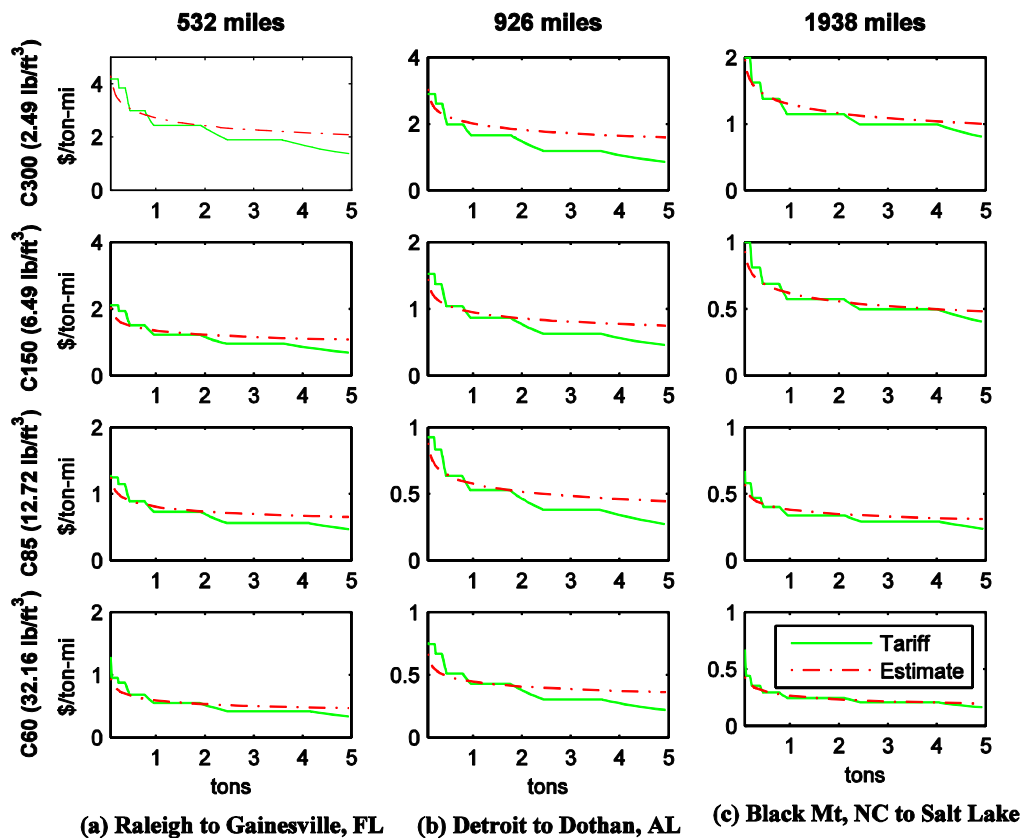

Figure 1.11. Comparison of estimated LTL rate to tariff rate.

### Estimate Compared to Tariff

In Figure 1.11, we show a comparison of the estimated LTL rates and tariff rates for four different load densities for each of our O-D test pairs, where the tariff rate is  $r_{\text{tariff}} = c_{\text{tariff}} / (qd)$ . All of the comparisons are for 2004 (i.e., using  $PPI_{LTL} = 104.2$ ), with all tariff rates discounted by 46.2512%.<sup>23</sup>

**Table 1.5. Comparison of Estimated LTL Charge to One-Time Internet-based Spot Quote (1000 lb, Class 100)**

Quote	Raleigh to Gainesville				Detroit to Dothan				Black Mt. to Salt Lake City			
	Serv Day	Insur Liabil	Transport Charge	Incr (%)	Serv Day	Insur Liabil	Transport Charge	Incr (%)	Serv Day	Insur Liabil	Transport Charge	Incr (%)
Est.			\$324.25				\$405.92				\$557.21	
1	2	\$2,000	288.69	-11	3	\$500	342.90	-16	6	\$500	516.30	-7
2	3	500	301.02	-	2	2,570	523.83	29	4	2,570	653.26	17
3	2	10,000	338.27	4	3	5,000	568.63	40	4	5,000	836.09	50
4	2	25,000	362.84	12	3	2,350	595.21	-	3	2,350	875.85	57
5	2	2,570	390.97	-	3	25,000	628.77	55	4	20,000	968.94	74
6	2	2,350	462.36	-	2	2,350	647.13	-	4	25,000	981.35	76
7	1	5,000	464.92	43	3	5,000	777.40	-	5	5,000	1,016.67	-
8	2	20,000	471.38	-					4	2,350	1,062.65	-
9	3	25,000	532.53	-								
10	3	5,000	534.88	-								
11	1	2,350	583.25	-								

### Estimate Compared to Spot Quote

In Table 1.5, for each of the three test O-D pairs, the estimated total charge total charge obtained from (1.5) is compared to multiple rate quotes obtained from an internet-based service (Freight101<sup>24</sup>) for a one-time shipment of a 1,000-lb, Class 100 LTL load. The quotes were obtained on August 17, 2006 for an August 28 shipping date, and all shipments were categorized as commercial with no special service or hazmat requirements. For each quote, the number of service days required for transit, the insurance liability for the load, and the total charge are listed. By way of comparison, the first row shows the estimated total charge,  $c_{LTL}$ , assuming a value of  $PPI_{LTL} = 119.5$  for July 2006,  $q = 0.5$  tons,  $s = 9.72$  lb/ft<sup>3</sup> (see Table 1.3), and  $d = 532$  miles. For each non-dominated quote—i.e., those that are not dominated by another quote with respect to a lower number of service days, greater insurance liability, or a lower total charge—the percentage increase of the quote's total charge over the estimated value  $c_{LTL}$  is shown. This increase over the estimated charge represents the premium paid for a one-time shipment through this freight service as compared to an average LTL shipment, most of which operate under longer-term contracts. The average premiums of the non-dominated quotes for each O-D pair are 12%, 27%, and 45%, respectively, and the average of these three averages is 28%. Most of the one-time quotes are greater than the estimated charge. This is not unexpected because the estimated charge reflects an average over all LTL shipments, of which relatively few would be one-time transactions. In general, the lowest quotes correspond to a higher number of service days and a lower insurance liability. With an estimated \$7,002 average value per ton (see Table

1.2), the average 1,000-lb LTL shipment used in the comparison would have an estimated value of around \$3,501 and a corresponding average liability of some larger amount.

## 1.7 Periodic Truck Shipments

When demand for truck transport between O-D points occurs repeatedly over a period of time, multiple demands are usually combined into shipments that occur periodically. Multiple demands are combined into single shipments because of the economies of scale associated with truck transport. Unlike a one-time shipment, where its size and time of occurrence is predetermined, periodic shipments require that the size and interval between shipments be determined. The exact timing and size of each shipment is determined by considering both the total transport costs ( $TC$ ) and the total shipment-related inventory costs ( $IC$ ), or what is termed the total logistics cost:

$$\text{Total Logistics Cost: } TLC = TC + IC = nc + IC, \quad (1.12)$$

where

$$n = \frac{f}{q} = \text{average shipment frequency (1/yr)}$$

$$t = \frac{q}{f} = \text{average shipment interval (yr)}$$

$$f = \text{expected annual demand (tons/yr)}$$

$$q = \text{average shipment size (tons)}$$

$$c = \text{transport charge (\$)}.$$

Since there is no cost savings associated with using more than a single truckload for each periodic shipment, a truck's maximum payload provides an upper bound on the size of each shipment:

$$q \leq q_{\max}. \quad (1.13)$$

As a result of (1.13), the number of shipments per year equals the number of truckloads. Note that this number is not restricted to integer values, which is reasonable if the demand will continue indefinitely.

### Aggregate Periodic Shipment

Since for periodic shipments  $q$  is not given and must be determined,  $f$  can be used in place of  $q$  when determining the aggregate demand and density of multiple items shipped together as part of a single load (cf. (1.3) and (1.4)):

$$f_{\text{agg}} = \sum_{i=1}^m f_i \quad (1.14)$$

$$s_{\text{agg}} = \frac{f_{\text{agg}}}{\sum_{i=1}^m f_i / s_i}. \quad (1.15)$$

Also, the aggregate value is the demand-weighted sum of the values of the items:

$$v_{\text{agg}} = \sum_{i=1}^m \frac{f_i}{f_{\text{agg}}} v_i. \quad (1.16)$$

### 1.7.1 Allocated Full-Truckload Charge

If inventory costs are small enough relative to transport costs, then a single shipment will always be comprised of an entire full truckload, so that  $q = q_{\text{max}}$ . In other situations, it is also likely that a consolidated load comprised of many different shipments, each with a different cube and weight, will only be transported as a full truckload (e.g., many big-box retailers only transport full truckloads from a DC to a store). In this case, although the different shipments could be combined into a single aggregate shipment, it is often more convenient to determine the transport rate for each shipment per ton-mile assuming that  $r$  is allocated to the product based on its maximum payload,

$$\text{FTL Rate (\$/ton-mi):} \quad r_{\text{FTL}} = \frac{r}{q_{\text{max}}}, \quad (1.17)$$

so that

$$\text{FTL Transport Cost (\$/yr):} \quad TC_{\text{FTL}} = f r_{\text{FTL}} d = n r d = w d. \quad (1.18)$$

where  $w$  is the monetary weight (\$/mi).

When it is reasonable to assume that a shipment will always be transported along with other shipments as part of a full truckload, then using  $r_{\text{FTL}}$  as the truckload transport rate for the shipment allows its transport cost to be considered in a location decision without having to know the exact mix of other shipments being transported—and the mix, size, and timing can change with each shipment without impacting the decision since only  $f$ , the annual demand, is used in the analysis—and its cost per mile for transport is independent of shipment size and distance. The formulation using  $w$  is useful in location analysis where (1.18) corresponds to the criterion used for the minisum transport-oriented single-facility location problem.

Another means of indirectly accounting for inventory costs when assuming full-truckload shipments is to place an upper limit on the average shipment interval. If  $t_{\text{max}}$  is the maximum shipment interval, then the FTL shipment size is the lesser of the following:

$$\text{FTL with Shipment Interval Constraint (\$/ton-mi):} \quad r_{\text{FTL}} = \frac{r}{\min\{f t_{\text{max}}, q_{\text{max}}\}}. \quad (1.19)$$

### 1.7.2 Range of Possible Transport Charges

Figure 1.8 shows the range of possible transport charges for a single shipment. The independent-shipment charge ( $c_0$  via (1.9)) corresponds to the maximum charge, while the full-truckload charge ( $c_{FTL} = r_{FTL} q d$ ) corresponds to the minimum likely charge. When multiple shipments are carried on a single truck as part of a consolidated load, each shipment's charge corresponds to an allocated portion of the total transport charge and is represented in the figure as any of the charges between by the independent and full-truckload charges. The consolidated charge approaches the full-truckload charge as the load reaches truck capacity. All of the charges are the same at the maximum payload. Note also that an allocated charge can be less the minimum charge for an independent shipment.

### 1.7.3 Total Logistics Costs

Selecting the size of a shipment on the basis of its *TLC* requires that both inventory carrying and transportation costs be specified as a function of  $q$ . Considering only cycle inventory costs,

$$TLC(q) = TC(q) + IC(q) = \frac{f}{q}c(q) + \alpha v h q, \quad (1.20)$$

where

$\alpha$  = average inter-shipment inventory fraction at origin and destination

$v$  = unit value of shipment (\$/ton)

$h$  = inventory carrying rate, the cost per dollar of inventory per year (1/yr).

The cost of holding one ton of inventory for one year is  $v h$  (\$/ton-yr). The inventory carrying rate is expressed as a fraction since the cost per dollar of inventory per year (\$/\$/yr) reduces to 1/yr. The parameter  $\alpha$  denotes the average fraction of the shipment size  $q$  that is held, in total, across the origin and the destination. For example, assuming that, on an annual basis, the supply and demand rates between a given O-D pair are constant, then, for a shipment of size  $q$ , the expected cycle inventory is  $q/2$  at each end,<sup>25</sup> meaning that the total cycle inventory across the origin and the destination is  $q$  and, therefore,  $\alpha = 1$ ; also, if supply is not constant (e.g., batch production) but the time of production is not coordinated with the time of shipment, then  $\alpha = 1$  (assuming production is equally likely to have occurred at anytime between shipments). If production at the origin is instantaneous, with a constant demand rate at the destination (i.e., the traditional EOQ model), then  $\alpha = 0.5$ . If, however, both production and consumption are instantaneous, then  $\alpha = 0$  (more on this case below). Finally, if the supplier is another firm and there are no negotiations with the supplier—e.g., to share the benefits of using an optimal shipment size that accounts for the supplier's inventory costs—then (from the point of view of the shipper-customer)  $\alpha = 0.5$ . Thus, annual inventory holding costs are given by  $\alpha v h q$ .

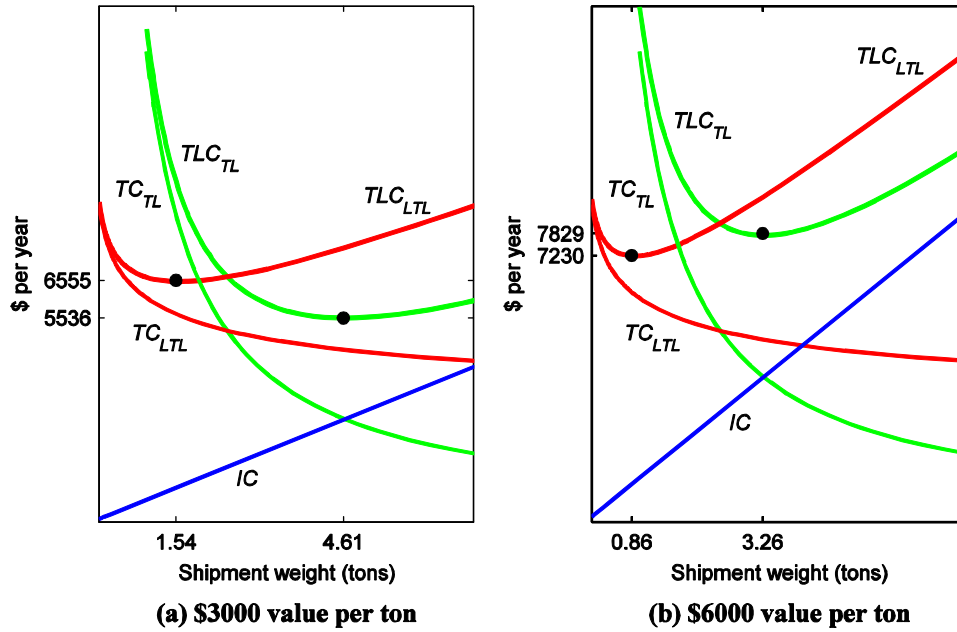

Figure 1.12. Total logistics cost comparison.

The total annual logistics cost for TL shipments is given by the sum of the transportation cost ( $TC$ ) and the cycle inventory costs ( $IC$ ) at the origin and destination, specifically

$$TLC_{TL}(q) = \frac{f}{q} \max\{c_{TL}, MC_{TL}\} + \alpha v h q \approx \frac{f}{q} r d + \alpha v h q. \quad (1.21)$$

Minimizing (1.21) with respect to  $q$  yields

$$q_{TL}^* = \min \left\{ \sqrt{\frac{f \max\{rd, MC_{TL}\}}{\alpha v h}}, q_{\max} \right\} \approx \sqrt{\frac{f r d}{\alpha v h}}, \quad (1.22)$$

where the approximation ignores the minimum charge and maximum payload restrictions.

Note that in-transit inventory costs are ignored because, for distances greater than one-day's travel, single-driver TL and LTL transit times are approximately equal (while team drivers can be used for faster TL transit, the cost per mile increases because of the additional labor costs). Also, the increase in value associated with a load reaching its destination, which is at a minimum equal to the cost of transporting the load, is ignored. Finally, for the case discussed above where  $\alpha = 0$ , total logistics cost consists only of transportation costs, and technically, the value of  $q$  that minimizes (1.21) is  $q = \infty$ ; by (1.22), however, this case results in  $q_{TL}^* = q_{\max}$ .

Using a similar approach, for a given shipment density  $s$  and road distance  $d$ , such that  $r_{LTL}(s, q, d)$  can be expressed simply as  $r_{LTL}(q)$ , the total annual logistics cost for LTL shipments is

$$\begin{aligned}
TLC_{LTL}(q) &= \frac{f}{q} \max \{c_{LTL}(q), MC_{LTL}\} + \alpha v h q = f \max \{r_{LTL}(q) d, MC_{LTL}/q\} + \alpha v h q \\
&\approx \frac{f}{q} r_{LTL}(q) q d + \alpha v h q = f r_{LTL}(q) d + \alpha v h q
\end{aligned} \quad (1.23)$$

Expression (1.23) cannot be solved in closed-form to determine the optimal LTL shipment size and, instead, must be solved numerically (using, e.g., Solver in Excel or `fminsearch` in MATLAB):

$$q_{LTL}^* = \arg \min_{\frac{150}{2000} \leq q \leq 5} TLC_{LTL}(q). \quad (1.24)$$

Overall, therefore, the optimal independent shipment size is

$$q_0^* = \arg \min_q \{TLC_{TL}(q_{TL}^*), TLC_{LTL}(q_{LTL}^*)\}. \quad (1.25)$$

Note from the development leading up to (1.25) that, for a given lane and a given product (density and weight) at a given annual demand, the value of the load,  $v$ , becomes the critical factor in determining whether LTL or TL is the preferred mode since cycle inventory costs increase as the load value increases, but transportation costs remain unchanged. This situation is illustrated in Figure 1.12 for shipments during 2004 between Raleigh, NC and Gainesville, FL, with  $f = 12$  tons per year,  $d = 532$  mi,  $s = 9.72$  lb/ft<sup>3</sup>,  $r = \$2$ /mi,  $K_{cu} = 3,000$  ft<sup>3</sup>,  $K_{wt} = 24$  tons,  $h = 0.2$ , and  $\alpha = 1$ . (In addition to  $TLC$ , inventory cost and transportation cost for each mode, labeled  $IC$  and  $TC$ , respectively, are shown in the figure.) At a value of  $v = \$3,000$  per ton (Figure 1.12(a)), TL is preferred and the optimal shipment size is 4.61 tons. In contrast, at a value of  $v = \$6,000$  per ton (Figure 1.12(b)), LTL is preferred and the optimal shipment size is 0.86 tons.

## 1.8 References

The following sources are recommended for further study:

- Ballou, R.H., 2004, *Business Logistics/Supply Chain Management*, 5th Ed., Englewood Cliffs, NJ: Pearson.
- Coyle, J.J., Novack, R.A., Gibson, B.J., and Bardi, E.J., 2011, *Transportation*, 7th Ed., South-Western.
- Daganzo, C.F., 1999, *Logistics Systems Analysis*, 3rd Ed., Berlin: Springer.
- Ravindran, A.R. and Warsing, Jr., D.P., 2013, *Supply Chain Engineering: Models and Applications*, Boca Raton, FL: CRC Press.

- <sup>1</sup> John Schulz, “State of Logistics 2022: Out of sync,” *Logistics Management*, 2022 [https://www.logisticsmgmt.com/article/state\_of\_logistics\_out\_of\_sync].
- <sup>2</sup> Schulz, J.D., “State of Logistics 2010: Business logistics costs fall 18.2 percent,” *Modern Material Handling*, Jun. 9, 2010.
- <sup>3</sup> Trunick, P.A., 2005, “Can we hold the line on logistics costs?” *Logistics TODAY*, Penton Media.
- <sup>4</sup> Logistics Costs and U.S. Gross Domestic Product, Federal Highway Administration, U.S. Dept. of Transportation, Aug. 25, 2005, [http://ops.fhwa.dot.gov/Freight/freight\\_analysis/econ\\_methods/lcdp\\_rep/index.htm](http://ops.fhwa.dot.gov/Freight/freight_analysis/econ_methods/lcdp_rep/index.htm).
- <sup>5</sup> CSCMP’s 33rd Annual State of Logistics Report, as reported in John Schulz, “State of Logistics 2022: Out of sync,” *Logistics Management*, 2022 [https://www.logisticsmgmt.com/article/state\_of\_logistics\_out\_of\_sync].
- <sup>6</sup> Private inventories: Annual average, seasonally adjusted, Federal Reserve Bank of St. Louis, Series ID A371RC1Q027SBEA. <https://fred.stlouisfed.org/series/A371RC1Q027SBEA#0> (accessed 2022.09.26).
- <sup>7</sup> Taggart, S., 1999, “The 20-Ton Packet,” *Wired*, Oct.
- <sup>8</sup> Economist, 2004, “Boxed in and clogged up,” *Economist*, Oct. 14.
- <sup>9</sup> Matheson, B., 2003, *Inbound Logistics*, Dec., p. 42.
- <sup>10</sup> SCAG, 2002, *SCAG Goods Movement Truck Count Study*, Sep. 25.
- <sup>11</sup> LTL average value taken from: National Transportation Statistics, Table 1-53: Value, Tons, and Ton-Miles of Freight Shipments within the United States by Domestic Establishments, Bureau of Transportation Statistics, Washington, DC (Updated April 2006).
- <sup>12</sup> PX column: Scherck, T.R., “A view of the future,” Colography Group.
- <sup>13</sup> Revised Hours-of-Service Regulations—2005, Federal Motor Carrier Safety Administration, <http://www.fmcsa.dot.gov/rules-regulations/truck/driver/hos/brochure2005.htm>.
- <sup>14</sup> M.G. Kay and D.P. Warsing, “Modeling truck rates using publicly available empirical data,” *International Journal of Logistics Research and Applications*, 12(3):165–193, 2009.
- <sup>15</sup> Producer price index industry data: General freight trucking, long-distance, truckload. Series ID=PCU4841214841212 (Dec. 2003 = 100 base). Bureau of Labor Statistics, U.S. Department of Labor. <http://www.bls.gov/ppi/home.htm>.
- <sup>16</sup> Termed “composite product” in Blumenfeld, D.E., Burns, L.D., Daganzo, C.F., Frick, M.C., and Hall, R.W., 1987, “Reducing logistics costs at General Motors,” *Interfaces* 17(1):26–47.
- <sup>17</sup> See [14] for details.
- <sup>18</sup> Producer price index industry data: General freight trucking, long-distance, LTL. Series ID=PCU484122484122. Bureau of Labor Statistics, U.S. Department of Labor. <http://www.bls.gov/ppi/home.htm>.
- <sup>19</sup> Pugh, W.W., 2005, *National Motor Freight Classification*, STB NMF 100-AF, National Motor Freight Traffic Association, Inc., Alexandria, VA.
- <sup>20</sup> As specified in *National Classification Committee Density Guidelines*, National Motor Freight Traffic Association, Inc., [http://www.nmfta.org/Portals/0/Documents/NCC Density Value Guidelines 2005 0809.pdf](http://www.nmfta.org/Portals/0/Documents/NCC%20Density%20Value%20Guidelines%202005%200809.pdf).
- <sup>21</sup> Popken, D.A., 1996, “An analytical framework for routing multiattribute multicommodity freight,” *Trans. Res.-B* 30(2):133–145.
- <sup>22</sup> CzarLite Online, <http://www.smc3.com/Applications/WebCzarLite/Entry.asp>.
- <sup>23</sup> See [14] for details.
- <sup>24</sup> Freight101.com, Instant Quote. <https://www.freight101.com>
- <sup>25</sup> Hall, R.W., 1985, “Dependence between shipment size and mode in freight transportation,” *Transportation Science* 19(4):436–444.